

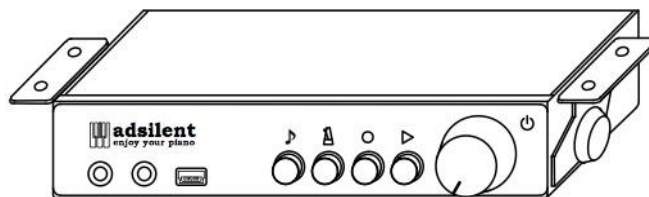

## User's Guide Version 1.03e-us



## **Intended Use**

The adsilent system is an electronic keyboard with a mechanical device for muting the acoustic piano / grand piano. The system is intended for retrofitting in acoustic pianos and grand pianos, possibly also directly from the factory in the piano factory. The system is used to play the piano via headphones. The system is used for practicing, making music and composing on the piano / grand piano. adsilent is intended for use in living environments with typical framework conditions such as 10-35 degrees Celsius, humidity in the range of 30-70 percent. The system can be used by piano players of all ages and levels.



Electronic products should not be mixed with general household waste. For proper treatment, recovery and recycling of old products, please take them to applicable collection points, in accordance with your national legislation.

## Index

### Chapter 1 Introduction

- 4 Warnings and caution messages
- 5 About adsilent
- 5 Warranty

### Chapter 2 Controls

- 5 Control box - front
- 6 Control box – back

### Chapter 3 Let's get started.

- 6 Get started with six simple steps.

### Chapter 4 The adsilent app

- 7 Installing the app and connecting your iOS or Android device to your adsilent system.

### Chapter 5 Operation via control box and piano keyboard

- 8 **Selecting an instrument via the TONE-button**
- 8 Selecting other instruments using the TONE-button and piano keys
- 9 Instruments and available effects
- 10 **Playing demo songs**
- 11 **Effects**
- 11 Reverb
- 11 Chorus/Leslie-cabinet
- 11 Delay
- 12 Transpose
- 12 Resetting all effects
- 12 **How to save your own User Presets**
- 13 Effects and corresponding piano keys

### 13 METRONOME

- 13 Metronome on/off
- 14 Metronome settings

### 15 Record and Play

### Chapter 6 Settings and configuration

- 16 Note repeat limit
- 16 Tuning
- 17 Expression
- 17 On-position for pedals
- 18 Proportional pedal
- 18 Upper and lower limit of the viewing range of the key sensors
- 19 Black keys volume
- 20 Single key volume
- 20 Resetting the single key volume
- 21 Reset to factory defaults
- 22 Initial sensor calibration
- 22 Re-calibration of the sensors

### Appendix: Technical Details

- 23 About MIDI
- 23 MIDI connection to other devices
- 23 MIDI channels
- 24 Technical specifications
- 25 FAQ
- 25 Contact

## Warnings and Caution Messages

### Please read this first!

- Do not play the adsilent system at a high volume for extended periods; you may damage your hearing. This is especially important when using headphones. If you think your hearing ability is impaired, consult your doctor.
- Turn off all audio devices when connecting to the adsilent system. Refer to the user's guide for each device.
- Set the volume level on all the devices to minimum before applying power. Also do that before other devices connected to the same power outlet are turned on or off.
- Connect the plug on the adsilent system power cable to a compatible AC outlet. Failure to do so will present a fire and electric shock hazard. If the power cable plug is not compatible with your AC outlet, consult your dealer.
- Do not plug several devices into the same AC outlet. This can overload the AC outlet, and lead to fire and electric shock hazard. It may also affect the performance of some devices.
- Do not place heavy objects on the power cable. A damaged power cable is a potential fire and electric shock hazard.
- If the power cable is damaged (i.e. cut or a bare wire is exposed), ask your dealer for a replacement.
- When disconnecting the power cable from an AC outlet, always pull from the plug. Never pull the cable.
- The cover of the unit should be removed only by qualified service technicians.
- Do not place liquid containers such as vases, potted plants, glasses, cosmetic bottles, medicines, etc., on top of your piano.
- Do not try to modify the adsilent system, as this could lead to fire or electric shock hazard.
- Do not locate the adsilent system in a place subject to excessive heat, low temperatures, or direct sunlight. This could be a fire hazard and may damage the finish and internal parts.
- Excessive humidity or dust can lead to fire or electric shock.
- If you notice any abnormality — such as smoke, odor, or noise — turn off the adsilent system immediately, and remove the power plug from the AC outlet. Consult your dealer for repair.
- If a foreign object or water gets inside the adsilent system turn it off immediately, and remove the power plug from the AC outlet. Consult your dealer.
- Even when the instrument is turned off, electricity is still flowing to the instrument at the minimum level. When you are not using the instrument for a long time or during electrical storms, remove the power plug from the AC outlet.
- Always remove the power plug from the AC outlet before cleaning the piano. Leaving the power plug connected presents a risk of electric shock.
- Connect the power plug to an AC outlet that is easy to access, so that the system can be disconnect from power easily when it is necessary.
- Always remove the power plug from the AC outlet during maintainance work on the adsilent system.
- FCC Information to the User according to Part 15.105  
Note: This equipment has been tested and found to comply with the limits for a Class A digital device, pursuant to part 15 of the FCC Rules. These limits are designed to provide reasonable protection against harmful interference when the equipment is operated in a commercial environment. This equipment generates, uses, and can radiate radio frequency energy and, if not installed and used in accordance with the instruction manual, may cause harmful interference to radio communications. Operation of this equipment in a residential area is likely to cause harmful interference in which case the user will be required to correct the interference at his own expense.

## Chapter 1 Introduction

### About adsilent

Congratulations - with adsilent you made the right choice. It is the most advanced silent system for retrofitting in acoustic pianos. Developed by experienced experts from Japan and Europe it offers unique features and a remarkable reliability. We wish you a lot of joy practicing piano, playing piano, composing and generally performing with your system.

### Warranty

Your adsilent comes with a five year manufacturer's warranty. The warranty covers defects that arise despite of normal use. Not covered are parts damaged due to wear and tear and defects caused by improper use or caused by foreign objects e.g. water, fire or due to opening the device. During the warranty period replacement parts are supplied free of charge in exchange for defective parts. All repairs need to be done/organized by a qualified dealer. The warranty does not apply to the adsilent app which is provided as a free supplement.

## Chapter 2 Controls

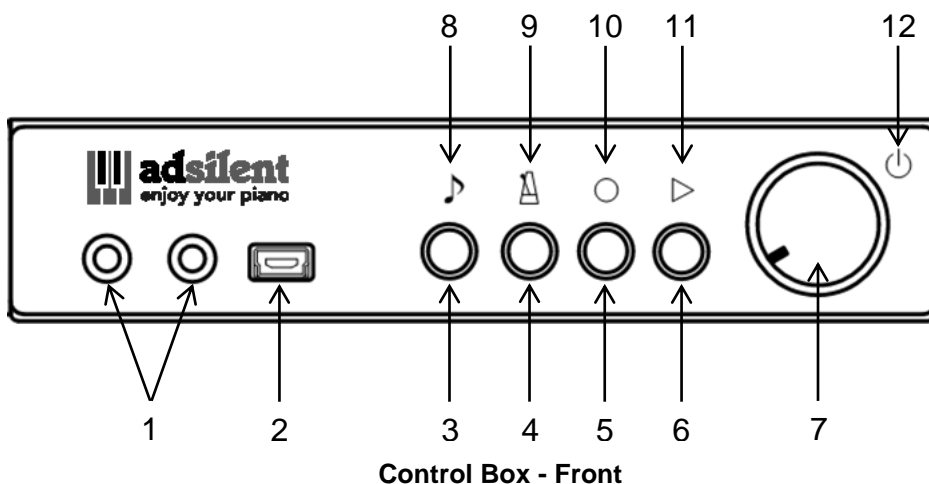

**(1) Headphone jacks**

**(2) USB MIDI** – USB-Mini-port  
For connect to a computer or other USB devices.

**(3) TONE** – For selecting a tone  
Used to select one of the Factory Preset- or User Preset Sounds.

**(4) METRONOME** - button for starting and stopping the metronome as well as making settings for the metronome.

**(5) RECORD** - button  
Start/Stop recording.

**(6) PLAY** - button  
Start/Stop playback.

**(7) POWER/VOLUME** – Combined knob for switching adsilent on/off as well as volume adjustment.

**(8) Tone-Status-LED** Indicates if MIDI data is flowing

**(9) Metronome-Status-LED**  
It's on when the metronome is active (flashes when metronome setup is active).

**(10) RECORD-Status-LED**  
It's on when the system is recording.

**(11) PLAY-Status-LED**  
It's on when the system is playing a recording.

**(12) Power-LED**  
It's on when the system is switched on. Flashes when there is an active Bluetooth connection.

**Chapter 2      Controls**

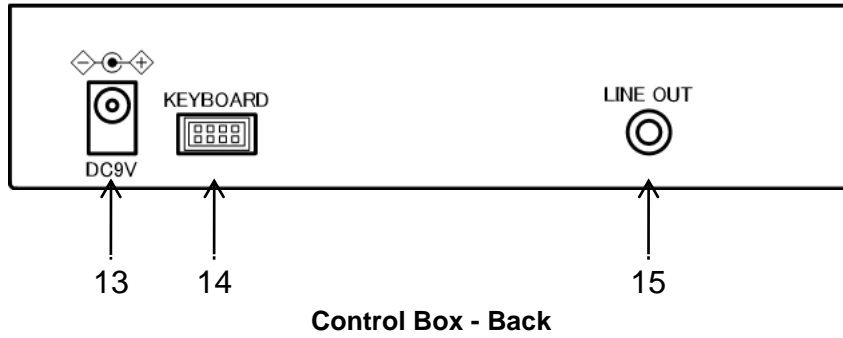

**(13) DC9V** – Connector for the power supply.

**(15) LINE OUT** – 3,5mm stereo jack for a connection to amplified speakers

**(14) KEYBOARD** - Connector for the cable from the key sensor rail

**Chapter 3      Let's get started.**

**Get started with six simple steps.**



**1. Press the power knob.**

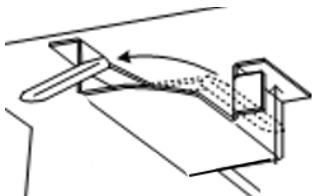

**2. Activate the mute rail.**



**3. Plug your headphones in and put them on.**

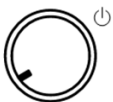

**4. Adjust the volume.**



**5. Select an instrument by pressing the TONE-button**

**6. Enjoy your piano performance via headphones.**

## Chapter 4 The adsilent app

The app is a useful supplement for your adsilent system. It will enable you to access additional features of the system

e.g. the 4 band equalizer. The app makes using the system even easier. The app is available in Apple's App-Store free of charge. The program currently supports six languages and will automatically set the language to the language used in your iOS device. In case your language is not supported yet it will default to English. The app requires an iPhone, iPod Touch, iPad using iOS 8.0 or higher.



**NEW:** The adsilent app is now also available for Android in the Google Play Store. Please note the requirements stated in the app store. Some Android devices may be incompatible with the app.

- **Locate the "adsilent" app in the App Store using the search option.**
- **Install the app** on your device.
- **Switch on Bluetooth** in your device.
- **Click on the adsilent icon** to start the app.
- **In the app click on Bluetooth and then click on adsilent.** That's how you connect your device to the adsilent system.

INFO: When the connection is established, the power LED at the adsilent control box starts flashing.

- **Click on "Load"** in order to load the current settings inside the adsilent system.
- **To make settings** or to switch features on and of **click on the feature.** All further steps are self-explaining.

INFO: The following main functions are available: Sound / Metronome / Rec & Play / Demo and Settings.

Have fun using the app and your adsilent system.

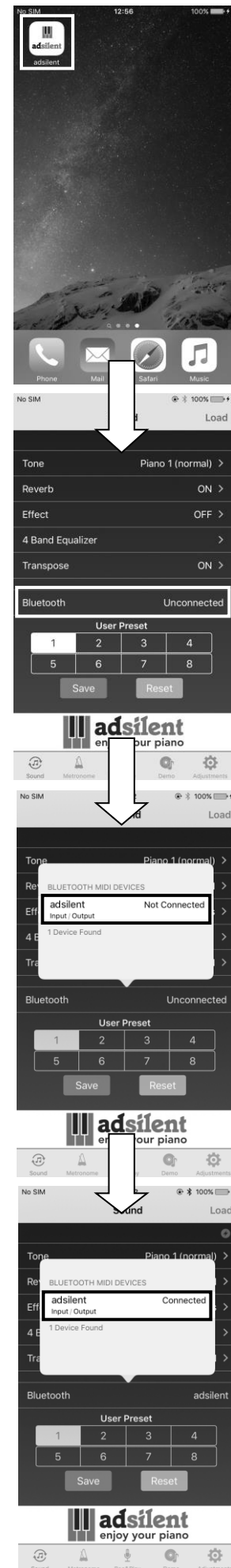

### Selecting an instrument



### Using the TONE-button

**TONE-button** – Using the TONE-key at the control box eight different instrument sounds or your eight user preset sounds can be selected. By pressing the button repeatedly switches between the sounds in the following order:

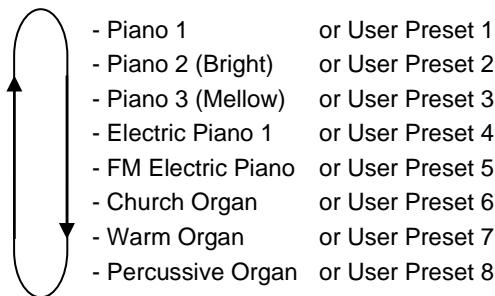

Each time you press the TONE-button a sample sound of the selected instrument gets played.

### Selecting other instrument sounds

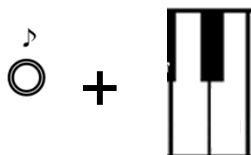

### Using the TONE-button and the piano keys

**TONE-button + Piano key** – Press and hold the TONE-button.

Then press the piano key that corresponds to the instrument sound you would like to select (see the list on the following page). When you play the key a sample sound of the instrument gets played.

Release the piano key and the TONE-button.

#### Note:

- When turning the system off and back on the system defaults back to piano or User Preset 1.
- Some instrument sounds feature effects like chorus and reverb as standard settings. Depending on the instrument sound you choose these settings can remain active after switching to different sound.
- The Rotary-speaker-effect is activated by default for the following instruments: Warm Organ, Percussive Organ, Drawbar Organ 1, Drawbar Organ 2, Rock Organ. When these instruments are selected the right pedal turns into a switch for changing the speed of the rotary effect.



## Chapter 5 Operation via control box and piano keyboard

### adsilent - Instruments and available effects



Left side of the piano keyboard



Right side of the piano keyboard

- |                                 |                                 |
|---------------------------------|---------------------------------|
| 1. * Piano 1 (normal)           | 45. Slow Strings                |
| 2. * Piano 2 (bright)           | 46. Strings + Horn              |
| 3. * Piano 3 (Mellow)           | 47. Synth Strings               |
| 4. Piano + Fast Strings ***     | 48. Choir                       |
| 5. Piano + Slow Strings ***     | 49. Choir 2                     |
| 6. Bright Piano + Reverb ***    | 50. Synth Voice                 |
| 7. * Electric Piano 1 ***       | 51. Trumpet                     |
| 8. * FM Electric Piano ***      | 52. Trombone                    |
| 9. Harpsichord                  | 53. Tuba                        |
| 10. * Church Organ              | 54. French Horn ***             |
| 11. * Warm Organ **             | 55. Brass + Trumpet ***         |
| 12. * Percussive Organ **       | 56. Synth Brass 1 ***           |
| 13. Electric Piano 2            | 57. Synth Brass 2 ***           |
| 14. Honk-tonk Piano             | 58. Synth Brass 3               |
| 15. Electric Piano 3 ***        | 59. Synth Brass 4               |
| 16. Clavinet ***                | 60. Soprano Sax                 |
| 17. Celesta ***                 | 61. Alto Sax                    |
| 18. Glockenspiel ***            | 62. Tenor Sax                   |
| 19. Musik Box ***               | 63. Baritone Sax                |
| 20. Vibraphone ***              | 64. English Horn                |
| 21. Santur ***                  | 65. Bassoon                     |
| 22. Drawbar Organ 1 **          | 66. Clarinet                    |
| 23. Drawbar Organ 2 **          | 67. Piccolo                     |
| 24. Rock Organ **               | 68. Flute                       |
| 25. Small Church Organ          | 69. Recorder                    |
| 26. Reed Organ                  | 70. Pan Flute                   |
| 27. French Accordion ***        | 71. Ocarina                     |
| 28. Harmonica ***               | 72. Synth Lead 2 (sawtooth) *** |
| 29. Bandoneon ***               | 73. Synth Lead 5 (charang)      |
| 30. Acoustic Guitar (nylon) *** | 74. Synth Lead 6 (voice)        |
| 31. Acoustic Guitar (Steel) *** | 75. Synth Lead 8 (bass + lead)  |
| 32. Electric Guitar (jazz) ***  | 76. Synth Pad 2 (warm)          |
| 33. Chorus Guitar ***           | 77. Synth Pad 3 (polysynth)     |
| 34. Overdrive Guitar ***        | 78. Synth Pad 4 (choir)         |
| 35. Distortion Guitar ***       | 79. Synth Pad 5 (bowed)         |
| 36. Acoustic Bass               | 80. Synth Pad 7 (halo)          |
| 37. Finger Electric Bass        | 81. FX 3 (crystal)              |
| 38. Slap Bass                   | 82. FX 4 (atmosphere)           |
| 39. Synth Bass                  | 83. FX 5 (brightness)           |
| 40. Violin                      | 84. FX 7 (echo)                 |
| 41. Cello                       | 85. Sitar                       |
| 42. Tremelo Strings             | 86. Koto                        |
| 43. Harp                        | 87. Bagpipe                     |
| 44. Strings                     | 88. Streeel Drums               |

\* These instrument sounds can be selected via the TONE-button.

\*\* Rotary speaker effect - Adjustable speed via right pedal.

\*\*\* Chorus

## Chapter 5 Operation via control box and piano keyboard

### Playing demo songs



**Press the PLAY-button for about 2 seconds.** The PLAY-LED starts flashing.

Release the PLAY-button and wait for the playback of the first demo song to start or **press one of the first ten white keys in the bass to select a song.**

Press the PLAY-button again to stop the playback.

### Demo Songs

White Key #	Titel	Composer
1	Prelude (Wohltemperiertes Klavier I, No. 1)	Johann Sebastian Bach
2	Für Elise	Ludwig van Beethoven
3	Piano Sonate op. 72-2 „Mondschein“ 1 <sup>st</sup> mov.	Ludwig van Beethoven
4	Shenandoah	American folk song
5	Danny boy	Ireland folk song
6	I love you, porgy	George Gershwin
7	Someday my prince will come	Frank Churchill
8	All the things you are	Jerome Kern
9	Someone to watch over me	George Gershwin
10	My wild Irish rose	Chauncey Olcott

## Chapter 5 Operation via control box and piano keyboard

### Effects

adsilent offers various sound effects. They can be adjusted individually. These effects are reverb, chorus/Leslie(Rotary), delay and transpose. The settings for sound effects return to their factory defaults after switching the system off and back on. The sound effects are available for most instrument sounds but not for all.

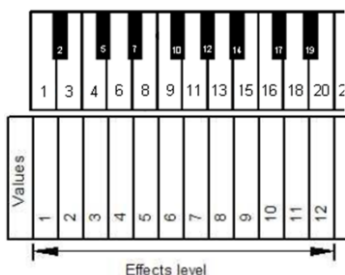

### Reverb

**Press and hold** the **TONE-** and the **METRONOME-button**.

Play

- Piano key 28, for reverb like in a room.
- Piano key 30, for reverb like in a hall.
- Piano key 32, for reverb effect off.
- One of the first twelve white piano keys in the bass to adjust the intensity of the reverb effect.

**Release the TONE- and the METRONOME-button** for saving your settings.

### Chorus/Leslie-Cabinet (Rotary)

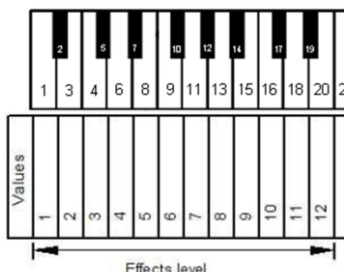

**Press and hold** the **TONE-** and the **METRONOME-button**.

Play

- Piano key 40, for Chorus effect.
- Piano key 42, for Leslie-cabinet effect (Rotary).
- Piano key 44, for Delay effect.
- Piano key 45, for all effects off.
- One of the first twelve white piano keys in the bass to adjust the intensity of the chorus effect.

**Release the TONE- and the METRONOME-button** for saving your settings.

### Note:

The Leslie-cabinet effect (Rotary) changes the function of the pedals! The right pedal switches between fast and slow rotary effect. The left pedal switches the Leslie-cabinet effect into stand-by till it is pressed again. In order to return the pedals to their normal operation, the Leslie-cabinet effect needs to be switched off by the steps explained above.

## Chapter 5 Operation via control box and piano keyboard

### Effects



#### Transpose

**Press and hold** the **TONE-** and the **METRONOME-button**.

#### Play

- **Piano key 64**, for transposing down.
- **Piano key 68**, for transposing up.
- **Piano key 66**, for transpose effect off.

**Release the TONE- and the METRONOME-button** for saving your settings.

**Note:** The selected setting for transpose remains active if you select a different instrument sound using the TONE-button & a piano key or via the adsilent app. The settings for sound effects return to their factory defaults after switching the system off and back on.



#### Resetting all effects

**Press and hold** the **TONE-** and the **METRONOME-button**.

Play **piano key 88**, to reset all effects to factory defaults.

**Release the TONE- and the METRONOME-button** for saving your settings.

### How to save your own User Presets

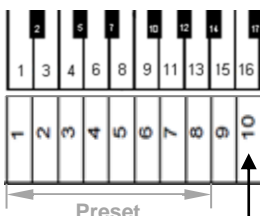
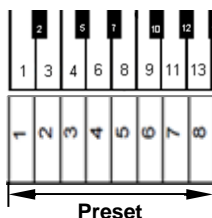

User Presets are eight memory cells for a tone and it's effects. The presets can be selected by pressing the tone button. In a new system the presets are filled with standard values. These standards can be overwritten by your preferred values. **IMPORTANT:** User Preset 1 stores the values used by adsilent immediately after it gets switched on.

Step 1: **Press and hold first the TONE- and then also the RECORD-button**, until you hear a bell sound in the headphones. **Keep the buttons pressed**.

Now the first eight white piano keys from the left are used to select the preset.

Step 2: **Press and hold** the piano key for the preset you want to use for about 5 seconds or more till you hear a bell sound twice. When you hear that, the values are saved and you can release the key and the buttons. The system saves the tone and the effects settings that are currently selected.

#### How to reset all User Presets to factory defaults

**After step 1 as explained above, press and hold the tenth white piano key from the left for 5 seconds or more** till you hear a bell sound twice.

Effects and corresponding piano keys

Bass End of Keyboard

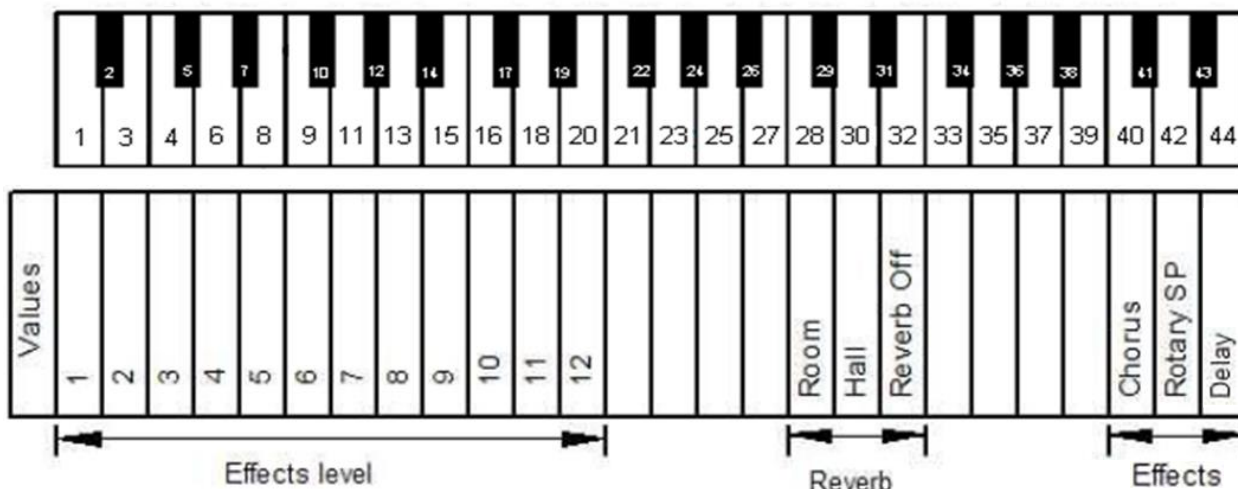

Treble End of Keyboard

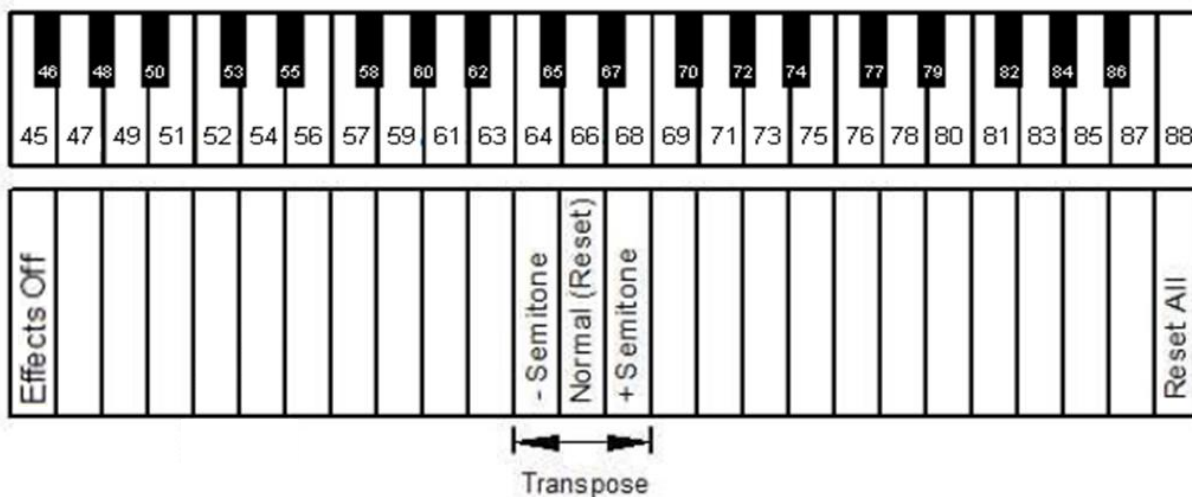

METRONOME

adsilent has a built-in metronome with adjustable beat, tempo and volume.



**Metronome ON/OFF**

Press the METRONOME-button to start the metronome. The "POWER"-LED flashes with the beat of the metronome.

Press the METRONOME-button again to stop the metronome.

### Metronome settings



Press and hold the METRONOME-button for about two seconds.



The METRONOME-LED starts flashing and you can hear the metronome in the headphones. You are now in the configuration mode for the metronome.

See below.

**Beat** – The following beat settings are available: 0, 2, 3, 4, 5, 6, 8. Play the corresponding piano key for the beat you would like to

See below.

**Tempo** – The tempo can be entered using the first 10 white piano keys in the bass. Each key represents a number that can be entered. The tempo gets entered as a three digit number. Tempo settings below 100 need to begin with a leading 0, e.g. 060 for 60. The tempo range is 030 to 250.

See below.

**Volume** – See illustration below.



Press the METRONOME-button again to exit the configuration mode. The METRONOME-LED stops flashing and is now always on. The metronome stays on until the METRONOME-button is pressed another time.

**Note:** Your metronome settings remain active also when the system gets switched off and back on.

Left side of the piano keyboard

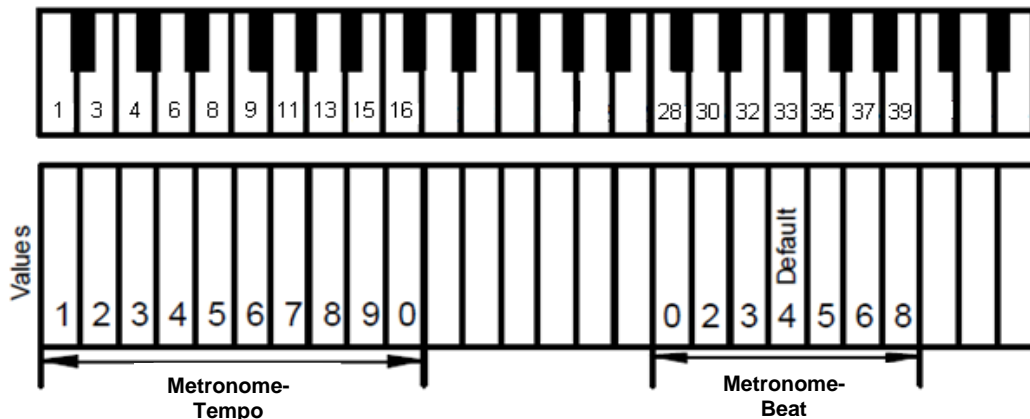

Right side of the piano keyboard

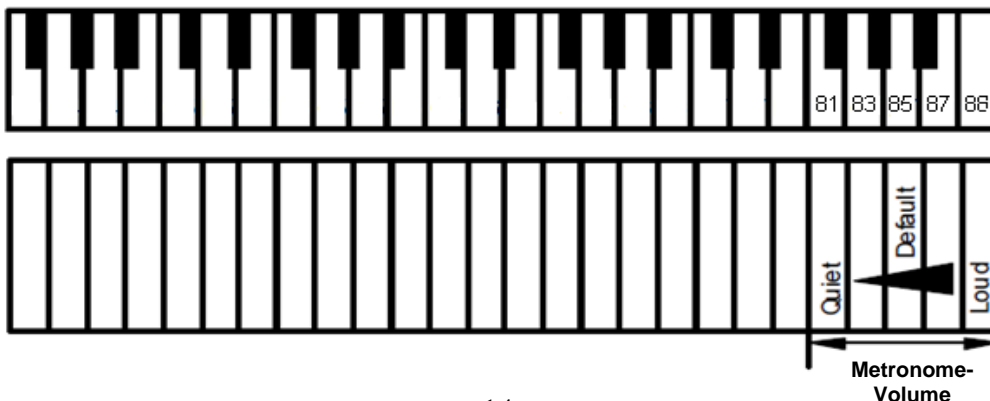

Record and Play

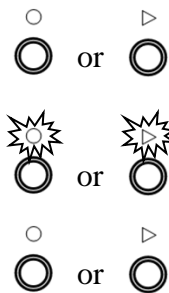
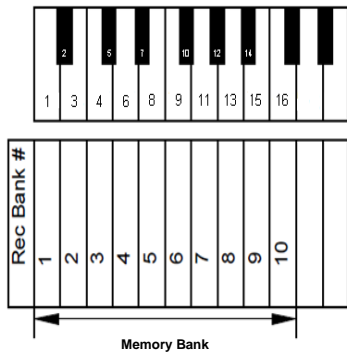

Recording & Playback

The first 10 white piano keys in the bass are used to select the memory bank for recording or playback.

**Press and hold** the piano key corresponding to the memory bank you would like to use for recording or playback.

All further steps are the same for recording and playback. Simply replace the RECORD-button with the PLAY-button if you would like to use playback instead of recording.

**Now press the RECORD-button.**

The **RECECORD-LED switches on**, to indicate that you are in the recording mode.

**Press the RECORD-button again to stop recording.**

Notes for recording:

- Recording starts when the first piano key or pedal is pressed,
- Previous recordings in the selected memory bank are overwritten by the new recording.
- You can select any instrument you like for recording. The instrument cannot be changed while recording.
- The metronome can be used while recording, it will not be recorded
- Each memory bank can store up to 10.000 key and/or pedal movements. When the memory is full the recording stops automatically.
- Recordings are saved also when the system gets switched off and back on.

Note for playback:

- While the system is playing, you can also play along.

### Note repeat limit

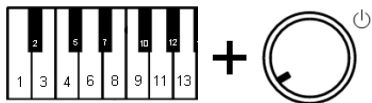

Press and **hold** piano keys 2 and 11, while switching the system on. You will hear a signal in the headphones to confirm that the system is in configuration mode.

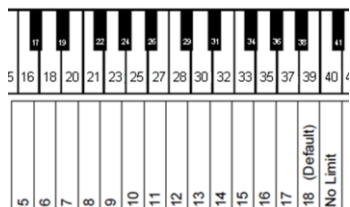

Set the limit by playing piano keys 16, 18 ... 39, 40.

Release piano keys 2 and 11, to save your setting and to exit the configuration mode.

**Note:** A limit that exceeds the capabilities of your acoustic piano can lead to undesirable results.

### Tuning

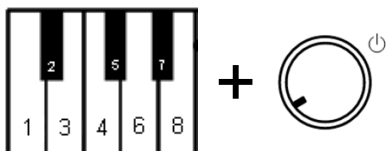

Press and **hold** piano keys 2 and 5, while switching the system on. You will hear a signal in the headphones to confirm that the system is in configuration mode.

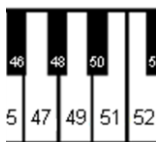

#### Play:

- Piano key 47 to lower the tuning. Play the key and count the steps till the desired level is reached. Step = 0,5 Hz, max. 13 Hz.
- Piano key 51 to raise the tuning. Play the key and count the steps till the desired level is reached. Step = 0,5 Hz, max. 13 Hz.
- Piano key 49 for returning to 440 Hz (Standard).

Release piano keys 2 and 5, to save your setting and to exit the configuration mode.

**Note:** The tuning feature may not be available in all piano sounds.

The selected setting remains active, also if the system is switched off and back on.



### Expression

adsilent can artificially change the feel & touch of your piano keyboard. This feature does not change the weight of the real piano keyboard, instead it just creates the impression of a lighter or heavier keyboard. Using this setting the system can be adjusted to match the touch and feel of your acoustic piano. Settings 1 or 2 are for a heavier keyboard, the feeling of a lighter keyboard is created by the settings 7 and 8. The factory default setting is 4 which equals the touch and feel of e.g. a Yamaha U3.

#### Selecting a expression setting

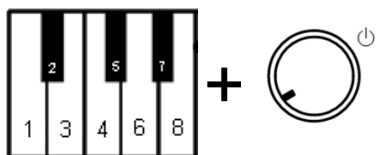

Press and **hold** piano keys 2 and 8, while switching the system on. You will hear a signal in the headphones to confirm that the system is in configuration mode.



Play piano keys 16, 18 ... 27 or 28 – Select the touch and feel of your choice by playing the corresponding piano key:

YAMAHA: 3–5  
KAWAI: 2–3



Release the two piano keys 2 and 8, to save your setting and to exit the configuration mode. The setting remains active also if the system is switched off.

### Pedal Settings

adsilent allows you to set the position in which the pedal effect is activated. Additionally can switch proportional pedalling on and off for the right pedal.

#### ON-Position for the pedals



Press and **hold** piano keys 2 and 3, while switching the system on. You will hear a signal in the headphones to confirm that the system is in pedal configuration mode.

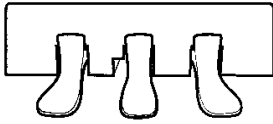

Press the left, right or center **pedal down to the point where you would like the corresponding pedal effect to be switched on and hold the pedal in this position.**



Press the **PLAY-button**. A signal confirms that the ON-position for the pedal has been set.



Release piano keys **2 and 3** to exit the configuration mode.

### Activating/deactivating proportional pedalling

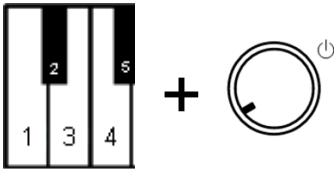

Press and **hold** piano keys **2 and 3**, while switching the **system on**. You will hear a signal in the headphones to confirm that the system is in pedal configuration mode.

Play:

- Piano key 18 for proportional pedal
- Piano key 16 for ON/OFF-pedalling.



Release piano keys **2 and 3** to exit the configuration mode.



### Upper and lower limit of the viewing range of the key sensors

#### Adjusting observed key movement

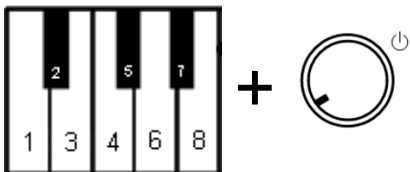

Press and **hold** piano keys **2 and 7**, while switching the **system on**. You will hear a signal in the headphones to confirm that the system is in configuration mode.

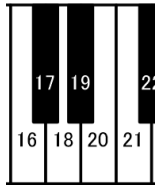

### Play

- Piano key 16 - Lower border -2 (up, higher than standard)
- Piano key 18 - Lower border -1 (up, higher than standard)
- Piano key 20 - Lower border 0 (Standard)
- Piano key 21 - Lower border +1 (down, lower than standard)

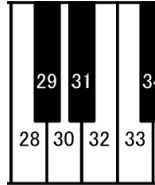

- Piano key 28 - Upper border -1 (up, higher than standard)
- Piano key 30 - Upper border 0 (Standard)
- Piano key 32 - Upper border +1 (down, lower than standard)
- Piano key 33 - Upper border +2 (down, lower than standard)



**Release piano keys 2 and 7** to exit the configuration mode.

### Black key volume

In case that the black key volume does not match the volume of the white keys, the volume of the black keys can be adjusted.

### Adjusting the black key volume

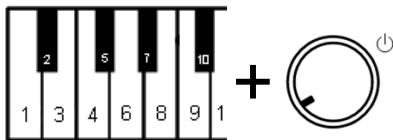

Press and **hold** piano keys **2** and **10**, while switching the system on. You will hear a signal in the headphones to confirm that the system is in configuration mode.

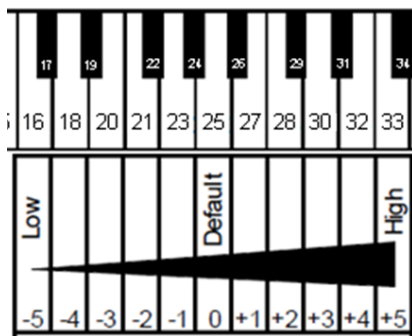

Play piano key **16, 18 ... 32 or 33** to select a volume that is as close as possible to the white key volume.

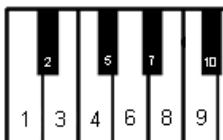

**Release piano keys 2 and 10** to exit the configuration mode.

## Single key volume adjustment

The volume of single keys can be adjusted in order to match the volume of the surrounding keys. The left side and the right side of the piano keyboard need to be adjusted separately. The volume can be adjusted in a range of -5 to +5 (Default is  $\pm 0$ ).

### Adjusting the volume



1. **Increasing the volume (lower notes, keys 1 - 44):**  
Press and hold piano keys 83 and 86, while switching the system on. Continue with step 2.

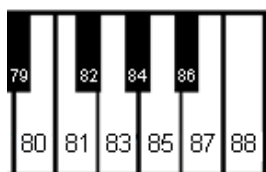

1. **Reducing the volume (lower notes, keys 1 - 44):**  
Press and hold piano keys 81 and 86 while switching the system on. Continue with step 2.



1. **Increasing the volume (higher notes, keys 45 - 88):**  
Press and hold piano keys 2 and 6, while switching the system on. Continue with step 2.

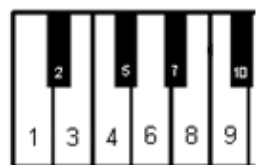

1. **Reducing the volume (higher notes, keys 45 - 88):**  
Press and hold piano keys 2 and 4 while switching the system on. Continue with step 2.



2. **Play the key that you would like to adjust several times**, till the desired volume has been reached. If needed adjust other keys as well.
3. **Release the piano keys from step 1**, in order to save your settings and to exit the configuration mode.

### Resetting the single key volume

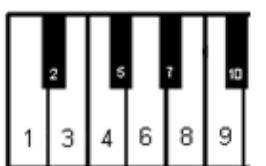

- Press and hold piano keys 2 and 9, while switching the system on, in order to reset all values to "0". Continue with step 3 above.

## Reset to factory defaults

### Attention!

When this process is completed, your adsilent system will not work anymore until the initial sensor calibration has been done. The initial sensor calibration is explained on the following pages. The following table shows the factory default values.

Factory Defaults	
Tone:	Piano
Reverb:	Room = Level 1
Effects:	Off
Transpose:	Off
4 Band Equalizer:	Flat / No Change
Metronome:	Beat: 4, Tempo: 120, Volume = Level 3
Recorded songs:	All deleted
Note repeat limit per second:	10
Initial sensor calibration:	Deleted
Re-Calibration:	Deleted
Automatic sensor calibration:	On
Expression:	4
On-position for pedals:	Deleted
Right pedal mode:	Proportional
Viewing range of the key sensors:	Upper limit = 0, Lower limit = 0
Continuous Note-On:	On
Black keys volume:	0
Single key volume:	all 88 keys = 0
MIDI Port:	A
Panel LED Brightness:	8
Piano type:	Upright piano
Tuning curve:	Pre-set curve

## Reset to factory defaults

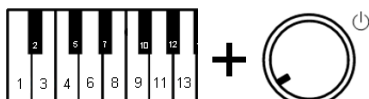

**Press and hold piano keys 2 and 12, while switching the system on.** You will hear a signal in the headphones and ...

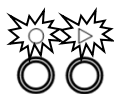

the „PLAY“- and „RECORD“-LEDs are flashing.



Release the piano keys 2 and 12.



The „PLAY“- and „RECORD“-LEDs turn off. Now the system has been reset to factory defaults.



**Press the "Power"-knob to turn off the system.**

## Initial sensor calibration

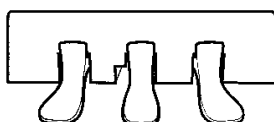
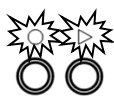

1. **Switch the system on.**
2. You will hear a signal in the headphones and the "PLAY"- and "RECORD"-LED are flashing alternately to show that the system is in the mode for initial sensor calibration.
3. **Press all piano keys, one after another, down the full way with similar force.** When releasing a key you will hear the tone for the key with a slight delay. This confirms that the key has been successfully calibrated.
4. **Press every pedal that has a pedal sensor, one after another, down the full way with similar force.** After a pedal was pressed a signal in the headphones confirms that the pedal has been successfully calibrated. There is a different signal for each pedal.
5. **Press the PLAY-button.** If the calibration was successful a signal can be heard in the headphones and the "PLAY"- and "RECORD"-LED will stop flashing. For pianos with just 85 keys press and hold RECORD and then press PLAY to finish the calibration.

### Notes:

- In case the system is switched off before the "PLAY"-button is pressed, the calibration cannot be completed and it needs to be repeated.
- It is recommended to have a brief pause between each key to assure proper calibration for each key.
- In case that keys or pedals could not be calibrated successfully, the configuration cannot be finished until these keys/pedals have been calibrated successfully. Press the keys or pedals again and then press the "PLAY"-button.
- The initial calibration resets the setting for expression.

## Re-Calibration of the sensors

The sensitivity of the key- and pedal sensors can change over time. To maintain excellent operation of the system the sensors need to be re-calibrated regularly.

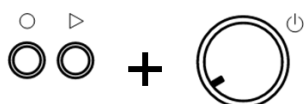

1. Press PLAY and RECORD while switching on the system.

Then please perform steps 2 to 5 as described above for the initial sensor calibration.

NOTE: In case you hear not tone for a key or a pedal - no re-calibration was necessary. You do not need to press all keys - just press keys and pedals which require a re-calibration.

## Appendix: Technical Details

### About MIDI

MIDI is an abbreviation for Musical Instrument Digital Interface. Information like what was played on a musical instrument, e.g. a note was played, can be transmitted via MIDI. MIDI is a common protocol worldwide.

### MIDI Connection to other devices

adsilent can be linked to a computer via USB-cable or via Bluetooth.

- For a computer: USB-cable / Bluetooth MIDI

### Connecting to a computer

If a computer is connected to your adsilent system - information is transferred as MIDI data to the computer. The MIDI data can be edited in the computer and stored on a hard drive or another storage medium.

### MIDI Channels

adsilent sends data of the piano keyboard via MIDI channel 1. The playback of recorded data is sent in MIDI channel 2.

### Example for the connection to a computer

Connect the computer to the USB-Mini-B-port at the control box.

As soon as the connection is established your computer will install the required MIDI-driver.

(Compatible operating systems: e.g. Windows 10)

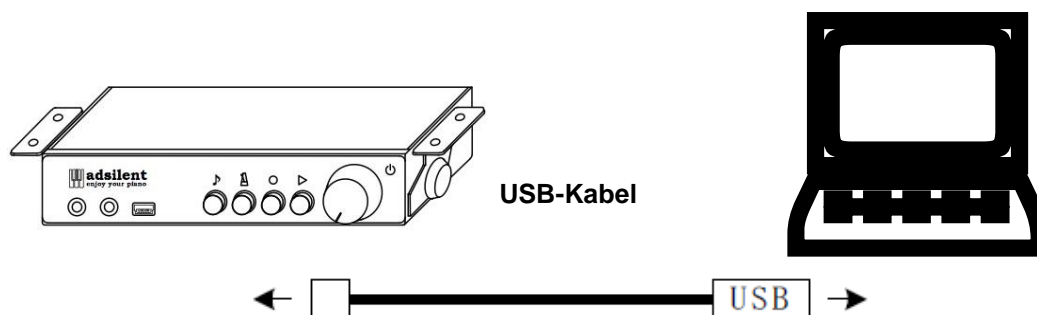

## Technical Specifications

<b>Polyphony</b>	max. 247 Notes
<b>Instruments</b>	127 via MIDI, 8 via Tone Button, 88 via piano keys or adsilent app.
<b>Effects</b>	Reverb (Room, Hall), Chorus (Leslie), Delay
<b>4 Band Equalizer</b>	+/- 10dB (via adsilent App)
<b>Metronome</b>	Beat: Off, 2, 3, 4, 5, 6, 8, Tempo: 30 – 250 Volume: 5 Levels
<b>Record/Playback</b>	Record: 10 Banks with about 10.000 Notes each Playback: Speed 0,5 - 2x (via adsilent app)
<b>Tuning</b>	± 13 Hz (427 – 440 – 453 Hz), Standard: 440 Hz
<b>Transpose</b>	+/- 1 Octave
<b>Pedal Positioning</b>	ON/OFF, Proportional (Damper Pedal only)
<b>Note repeat limit</b>	15 Levels
<b>Viewing range of the key sensors</b>	2 x 4 Levels
<b>Expression</b>	8 Levels
<b>Black keys volume</b>	± 5
<b>Single key volume</b>	± 5
<b>Demo Songs</b>	10
<b>Ports</b>	<b>Analog</b> 2 x Headphone, 1 x LINE-OUT <b>Digital</b> 1 x USB 2.0 Slave (MIDI)
<b>Wireless</b>	Bluetooth 4 BLE, 2.402 GHz – 2.480 GHz, EIRP (mW) < 2mW
<b>Input Voltage</b>	+9 VDV (Power Supply)
<b>Power consumption</b>	6W or less
<b>Control Box weight</b>	380g
<b>Control Box dimensions</b>	W: 143mm x D:79mm x H:27mm
<b>Accessories</b>	Headphone, Power supply, User Guide
<b>Optional accessories</b>	USB-cable, powered speakers, 2nd headphone.
<b>Related app</b>	adsilent App (requires iOS 8.0 or newer) *

\* Using the adsilent app many functions and settings can easily be operated via the touch screen of your iOS device. Technical specifications are subject to change without prior notice.



## FAQ

- **The device does switch on but doesn't play. And the PLAY- and RECORD-LED are flashing alternately.**
  - adsilent is in the mode for initial calibration. You need to complete the initial calibration.
- **The device does not switch on.**
  - Check the power supply for proper connection to the wall outlet and to the DC9V-input.
  - Check if the wall outlet has power.
  - If the problem continues please contact a qualified repair service.
- **Some notes sound louder or quieter than other or do not sound at all.**
  - It may be necessary to re-calibrate the system or the key volume/s need to be adjusted. See the instructions for re-calibrating the sensors. If the volume of the black keys differs from the volume of the white keys see the instructions for adjusting the black keys volume or use the single key volume adjustment.
- **The pedal doesn't work or "hangs".**
  - Likewise the pedal sensors need to be re-calibrated. See the instructions for re-calibrating the sensors. If the problem continues please contact a qualified repair service.
- **The tempo for the metronome cannot be adjusted.**
  - The tempo needs to be entered as a three digit number via the piano keyboard. Tempo settings below 100 need to begin with a leading 0, e.g. 060 for 60. The valid tempo range is 030 to 250. Tempo settings below 30 and above 250 will not be accepted.

### Contact:

**A. Dütz Handel & Service (Excellent Piano Installs©), Burgstallstr. 5, 90587 Obermichelbach, Germany  
Web: [www.adsilent.eu](http://www.adsilent.eu) - E-Mail: [sales@expin.de](mailto:sales@expin.de)**